

Standard Railing Styles

Standard Railing with Square Balusters

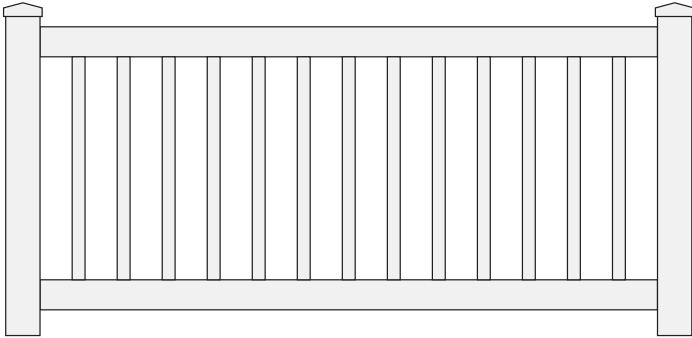

Standard Railing with Round Black Aluminum Balusters

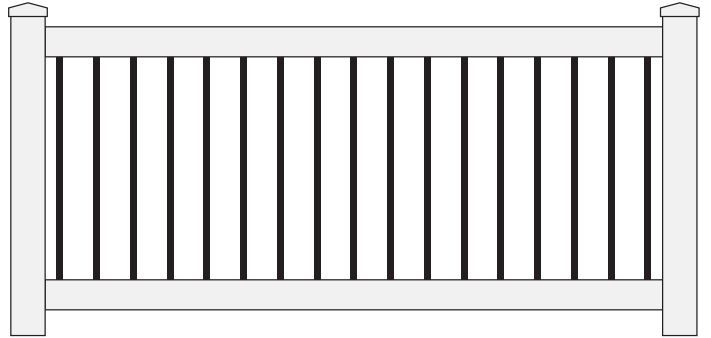

Standard Railing with "Colonial / Turned" Style Spindles

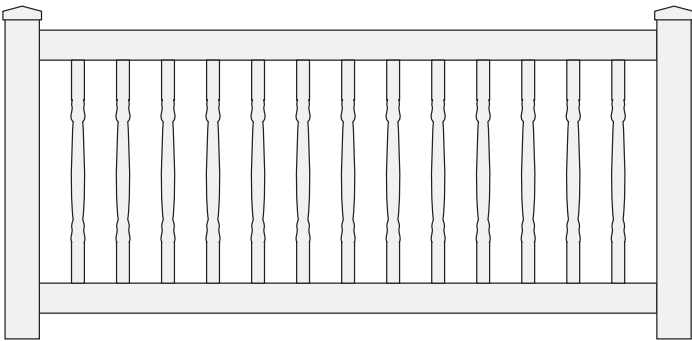

"Chippendale" Style Railing, *White Only*

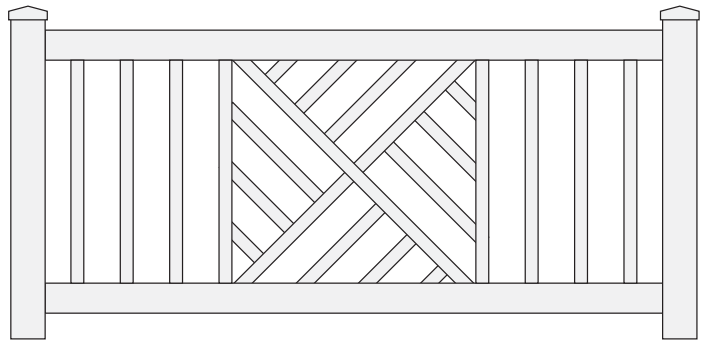

"Freeport" Style Railing, *White Only*

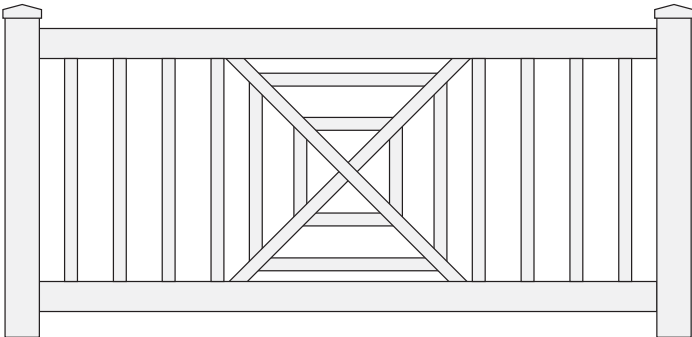

Specialty Railing Styles

"Boardwalk" Screen Panel (Black, white, or gray)

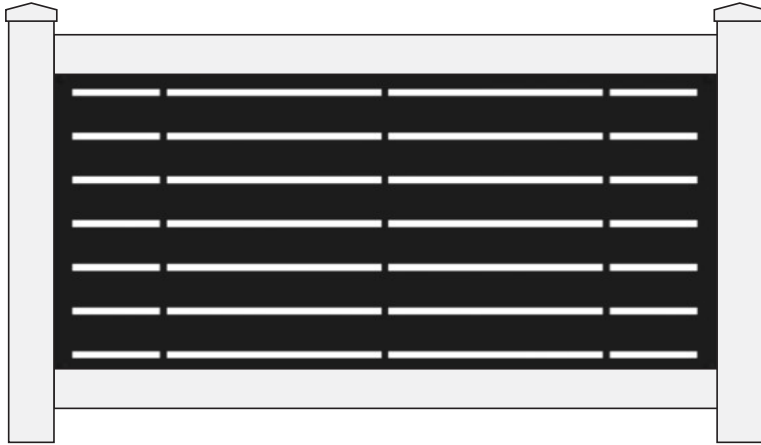

"Optic" Screen Panel (Black only)

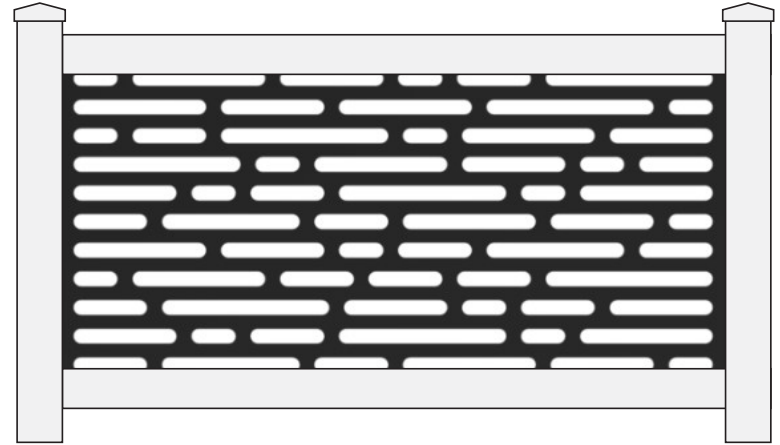

"Sanibel" Screen Panel (Black only)

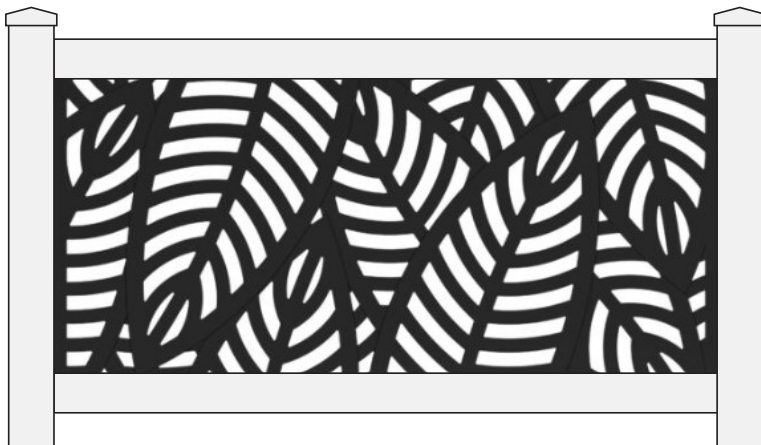

"River Rock" Screen Panel (Black only)

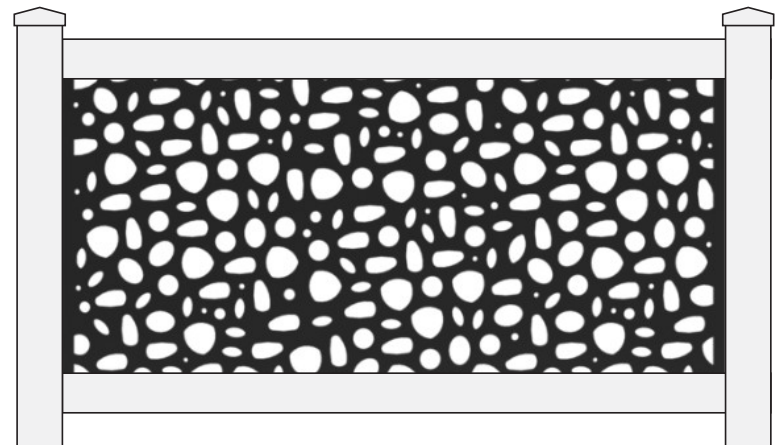

Top & Bottom Rail Details

T-shaped
top rail

Aluminum insert
in top and
bottom rail



*Not shown: 2" by 3.5"
rectangular bottom rail

Color Options

White

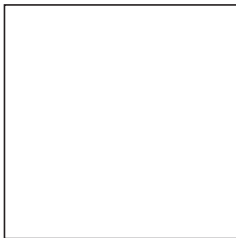

Sand / Tan

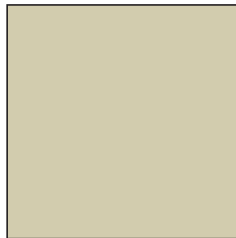

Clay / Adobe

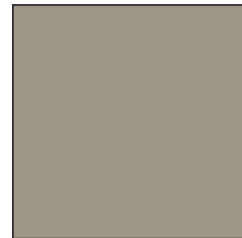

Post Cap Options

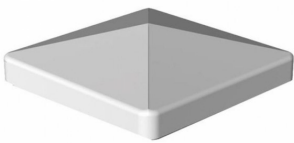

flat/standard

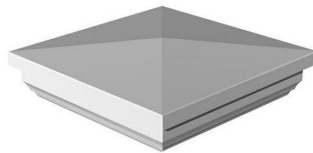

New England

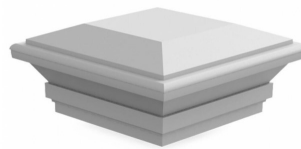

Contemporary



French Gothic